

# CLASSIC DUO OVAL

- pure simplicity and unpretentious elegance are what distinguish these baths
- bathing with a friend: two identical back rests and centrally positioned waste
- made of KALDEWEI steel enamel

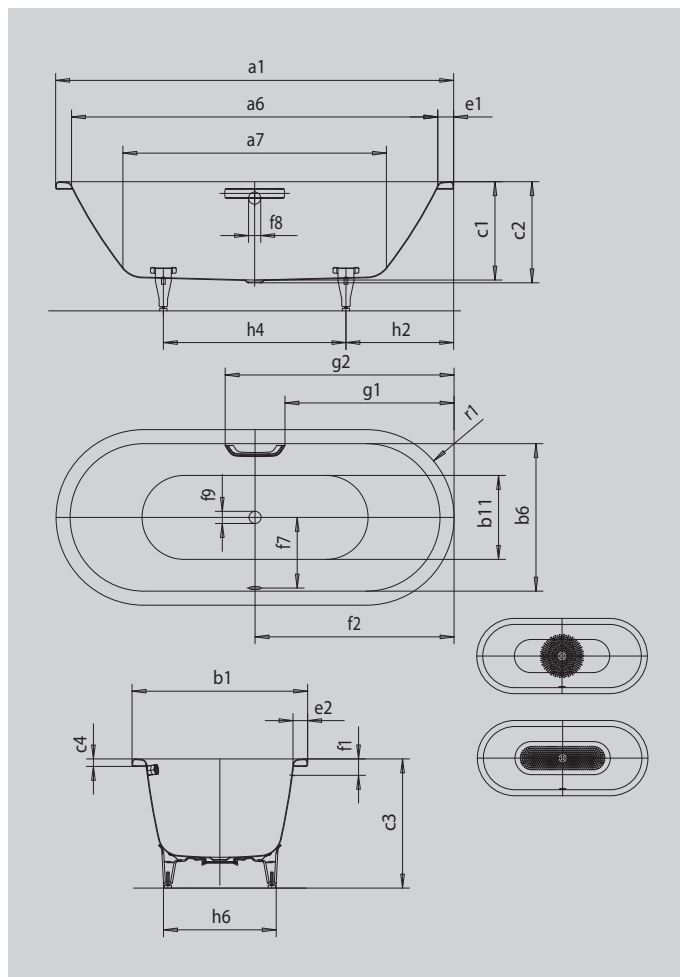

Similar illustration



## GRIP DISCREET OPULENCE



Model		116
External length	a <sub>1</sub>	1700 mm
Internal length (top)	a <sub>6</sub>	1580 mm
Internal length (bottom)	a <sub>7</sub>	1130 mm
External width	b <sub>1</sub>	700 mm
Internal width (top)	b <sub>6</sub>	580 mm
Internal width (bottom)	b <sub>11</sub>	450 mm
Depth inside	c <sub>1</sub>	420 mm
Depth incl. waste hole	c <sub>2</sub>	430 mm
Height with feet	c <sub>3</sub>	565 - 600 mm
Height of rim	c <sub>4</sub>	32 mm
Width of rim (foot end; long side)	e <sub>1</sub> ; e <sub>2</sub>	60; 60 mm
Distance top edge to centre of overflow hole	f <sub>1</sub>	70 mm
Distance bath edge to centre of waste hole	f <sub>2</sub>	850 mm
Distance centre of waste hole to centre of overflow hole	f <sub>7</sub>	280 mm
Diameter of overflow hole	f <sub>8</sub>	Ø 52 mm
Diameter of waste hole	f <sub>9</sub>	Ø 52 mm
Distance bath edge (foot end) to start of grip	g <sub>1</sub>	722 mm
Distance bath edge (foot end) to end of grip	g <sub>2</sub>	978 mm
Distance foot end of bath edge to centre of foot	h <sub>2</sub>	560 mm
Distance between the feet	h <sub>4</sub>	580 mm
Width of feet max.	h <sub>6</sub>	420 mm
External radius	r <sub>1</sub>	350 mm
Water volume		110 l
Net weight		44 kg
Diameter of anti-slip		Ø 288 mm
Full anti-slip		900 x 300 mm