



# INSTALLATION GUIDE

## WALL MOUNTED (D SHAPE) SURROUND

**To prevent Warranty Void, please ensure  
bath and surround are sealed with silicon**

25 John Street, Leichhardt, NSW, 2040  
t. 61 2 9518 0163 f. 61 2 9518 0216  
sales@bathe.net.au www.bathe.net.au



# Installation Instructions

1.

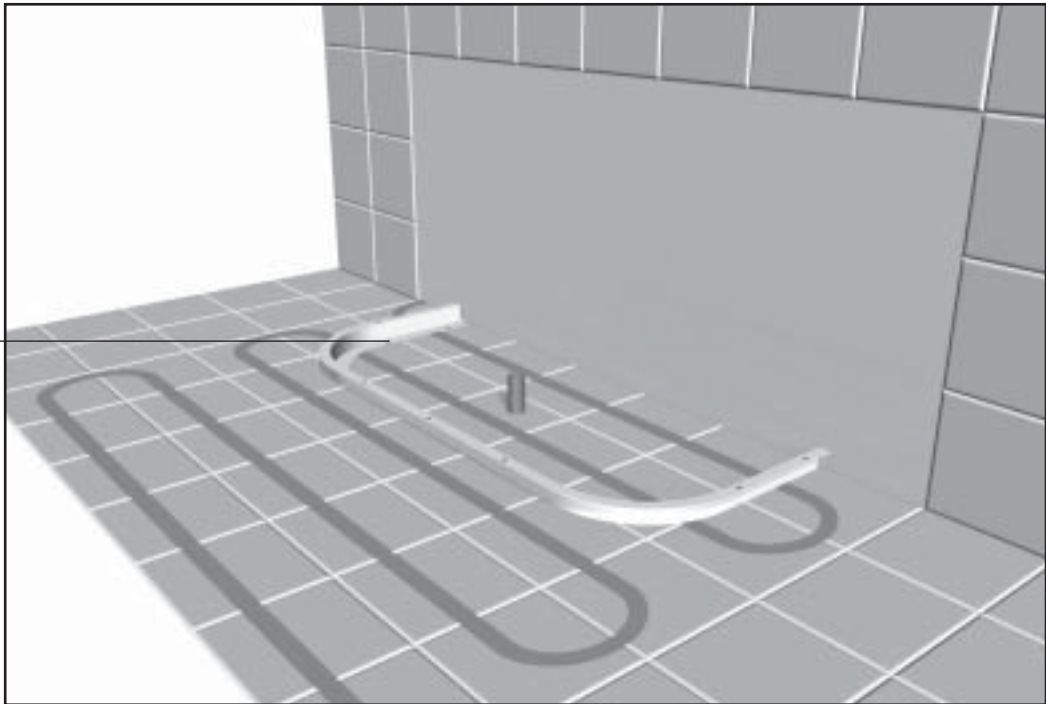
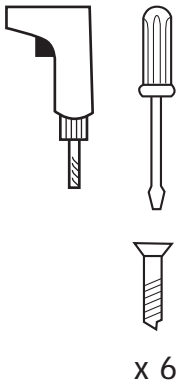

2.

PVC Tile Trim (profile)

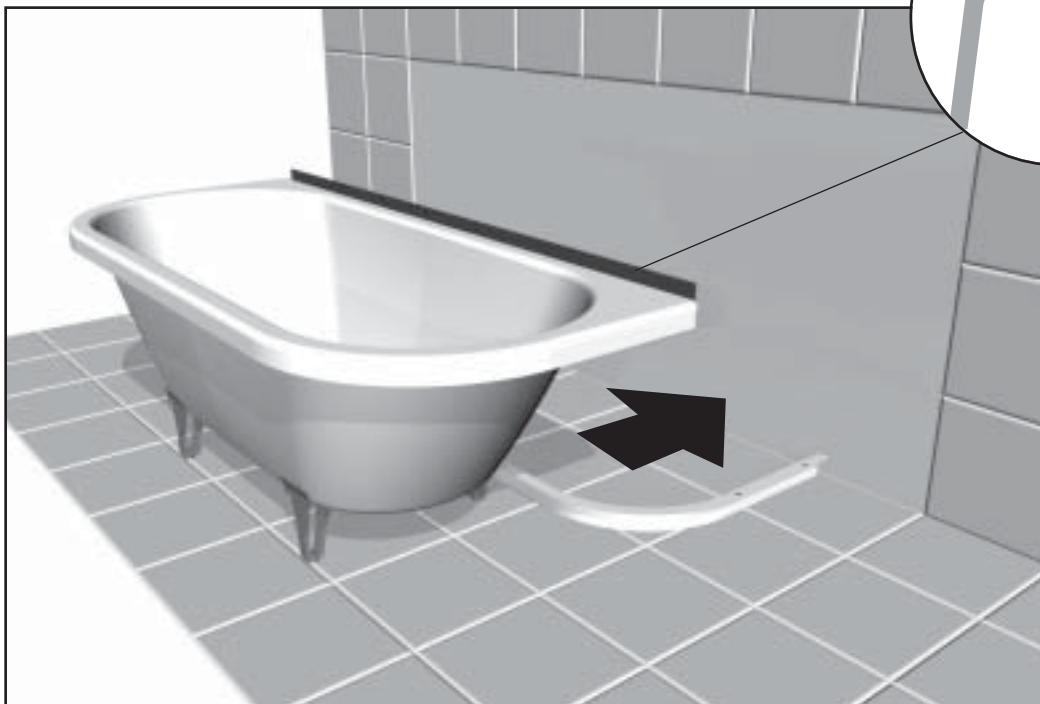
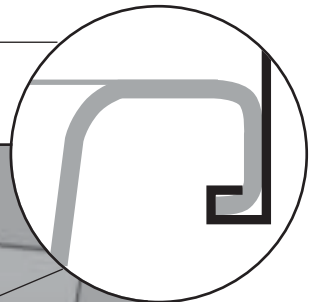

**NOTE: WHERE THE BATH IS TO BE LOCATED, THE FLOOR MUST BE LEVEL**

# Installation Instructions

3.

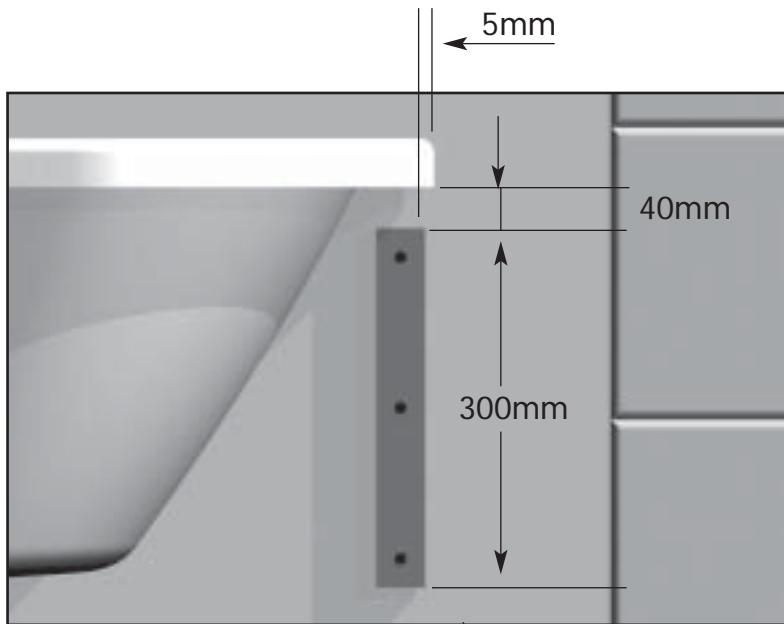

Batons not supplied  
300mm. 2 Required

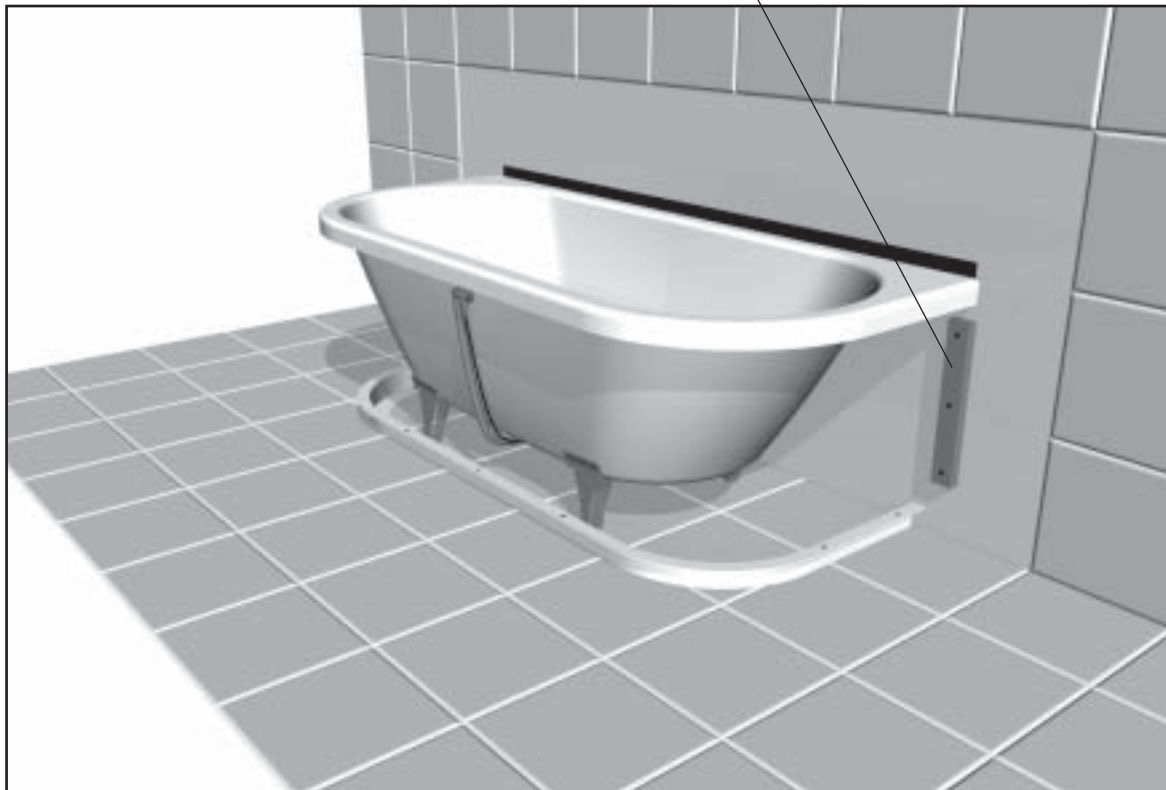

**NOTE: WHERE THE BATH IS TO BE LOCATED, THE FLOOR MUST BE LEVEL**

# Installation Instructions

3.



4.

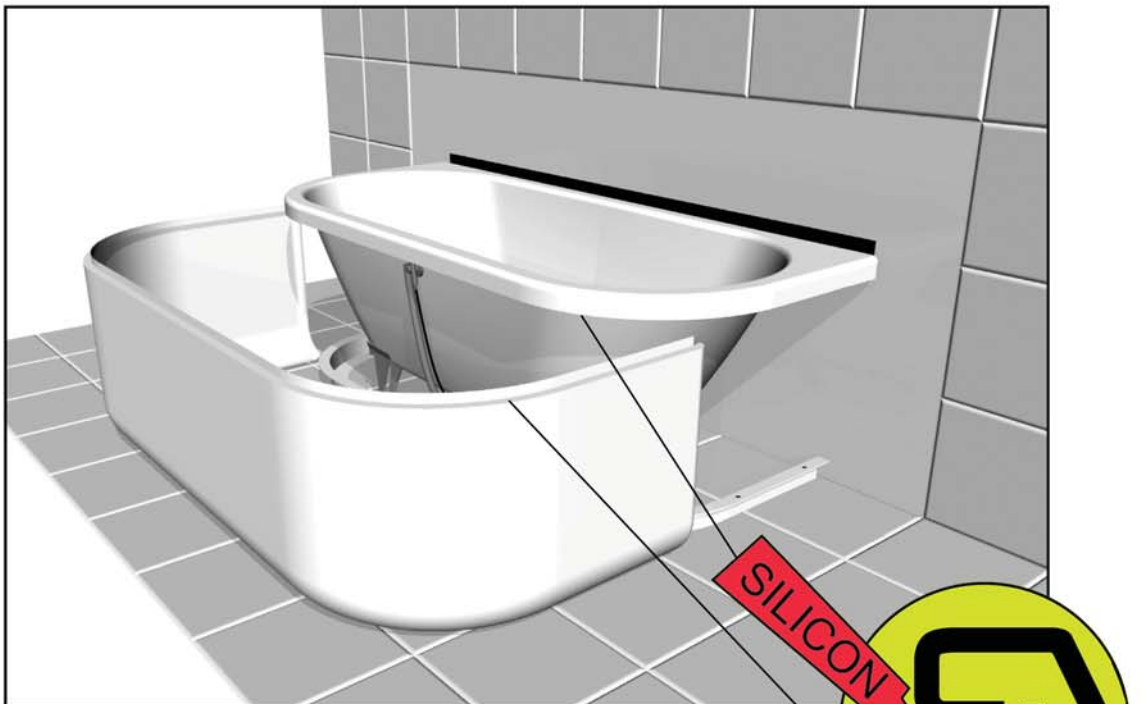

**IMPORTANT:**  
Ensure **SILICON**  
is used to seal  
surround.

**NOTE: WHERE THE BATH IS TO BE LOCATED, THE FLOOR MUST BE LEVEL**

# Installation Instructions

5.

Detail A

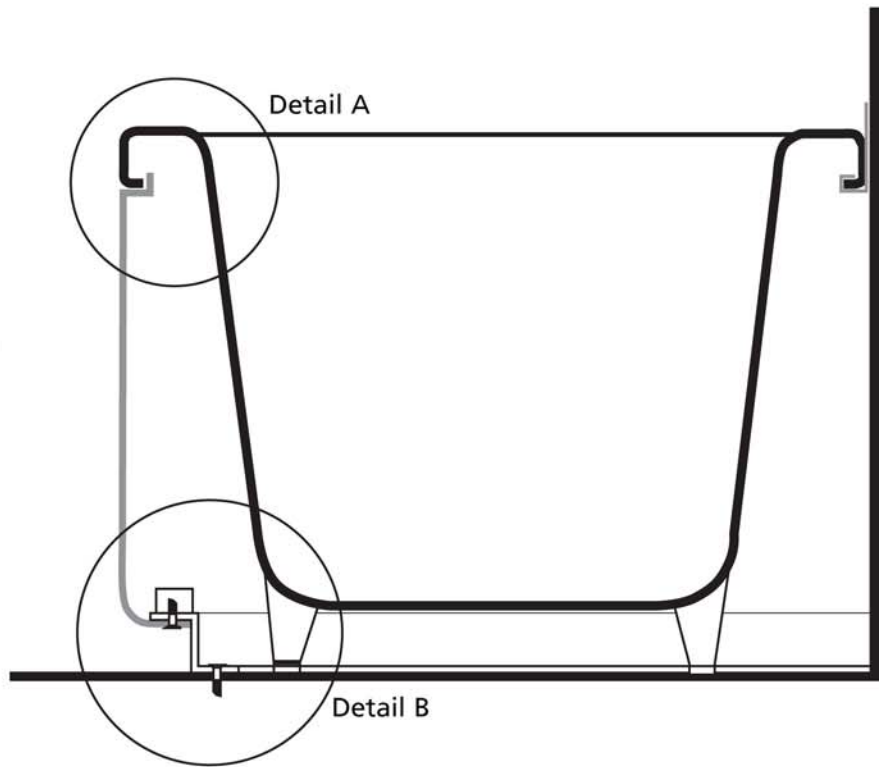
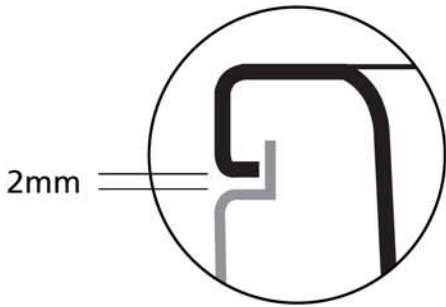

Detail B

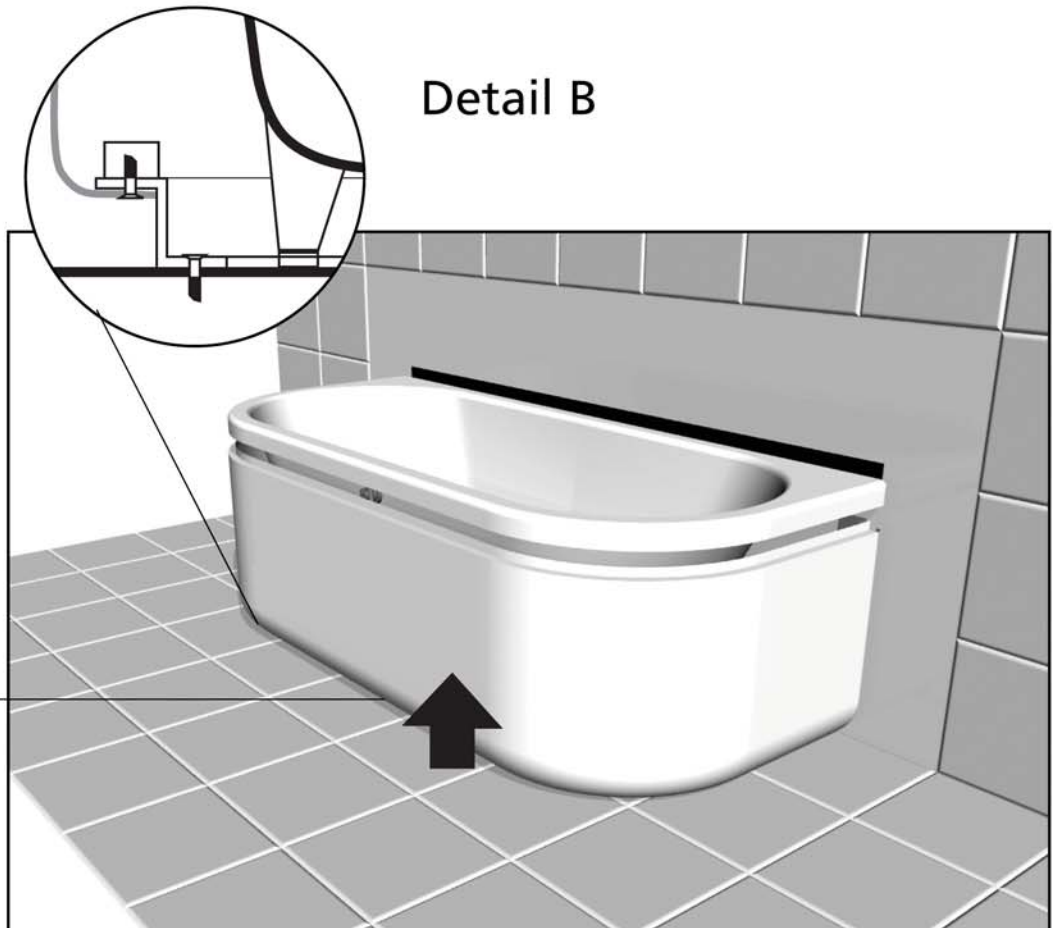

x7

**NOTE: WHERE THE BATH IS TO BE LOCATED, THE FLOOR MUST BE LEVEL**

## Installation Instructions

7.



**NOTE: WHERE THE BATH IS TO BE LOCATED, THE FLOOR MUST BE LEVEL**