



Installation Guide

Wall Mounted (D Shape) Surround

25 John Street, Leichhardt, NSW, 2040
t. 61 2 9518 0163 f. 61 2 9518 0216

sales@bathe.net.au
www.bathe.net.au

Installation Instructions

1.

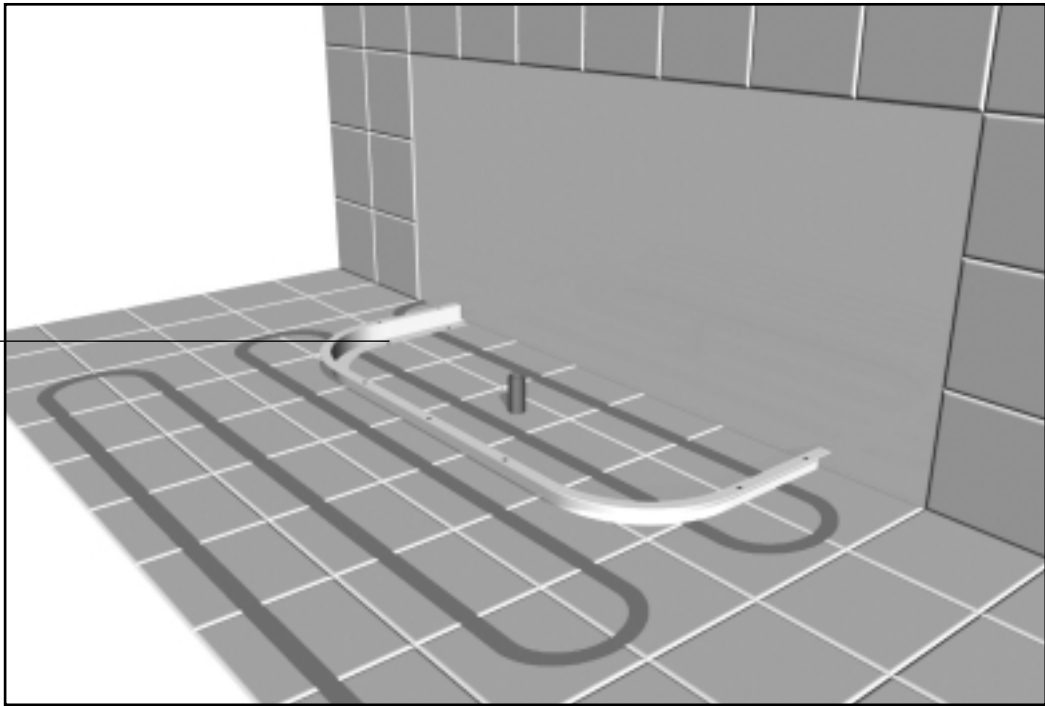
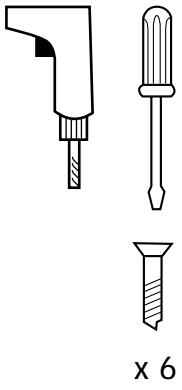

PVC Tile Trim (profile)

2.

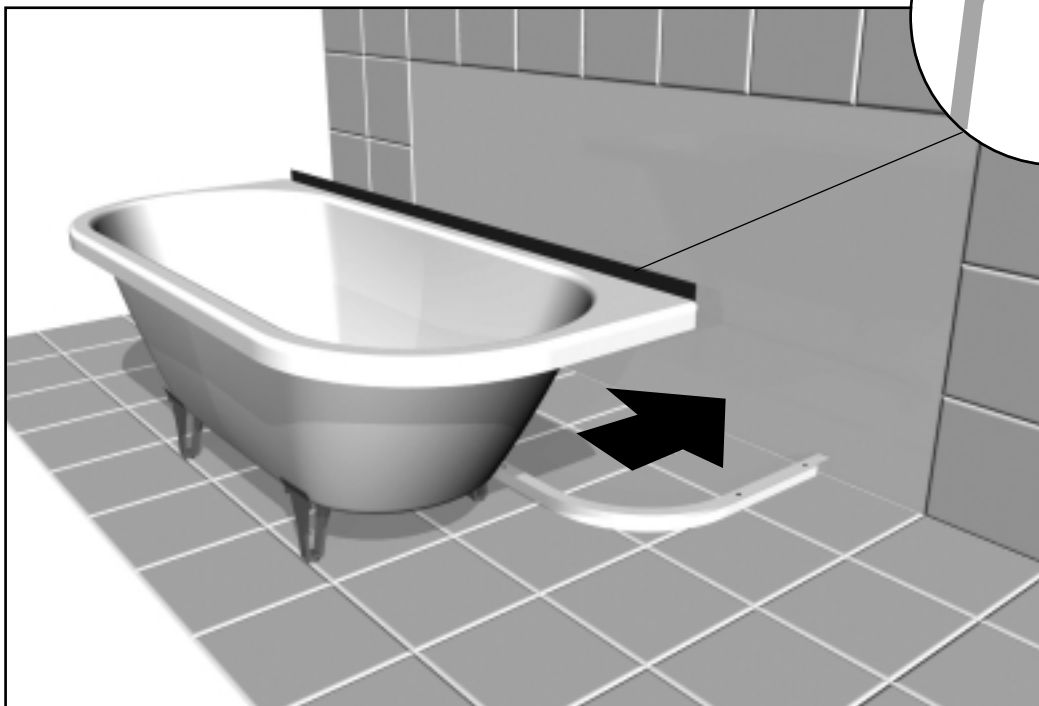

Installation Instructions

3.

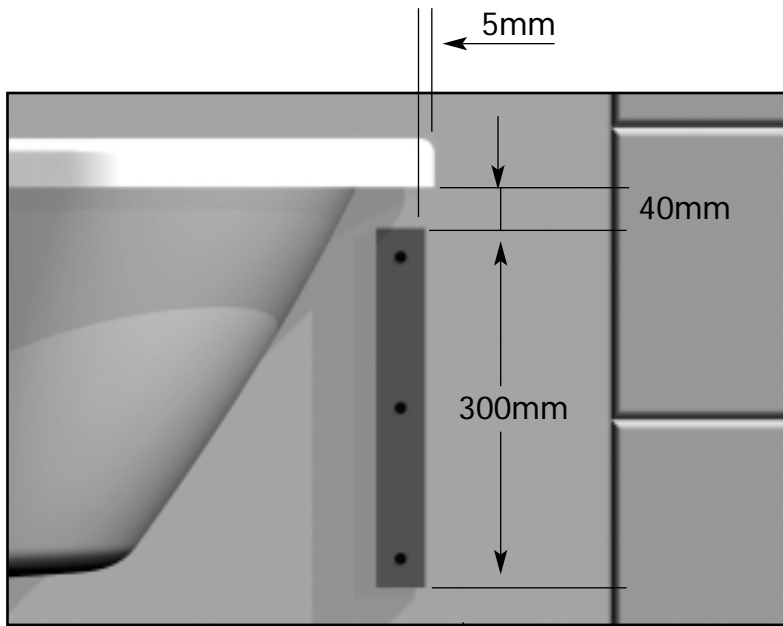

Batons not supplied
300mm. 2 Required

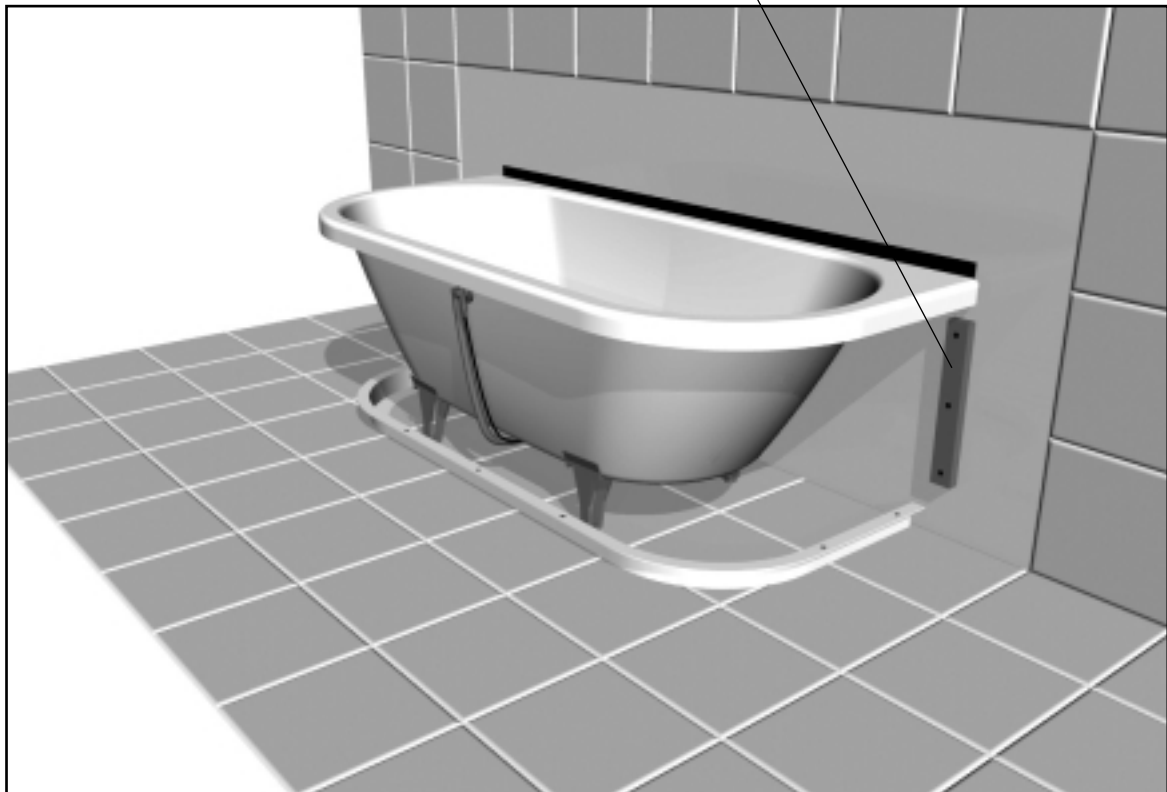

Installation Instructions

4.



IMPORTANT:
Ensure **SILICON**
is used to seal
surround.

5.

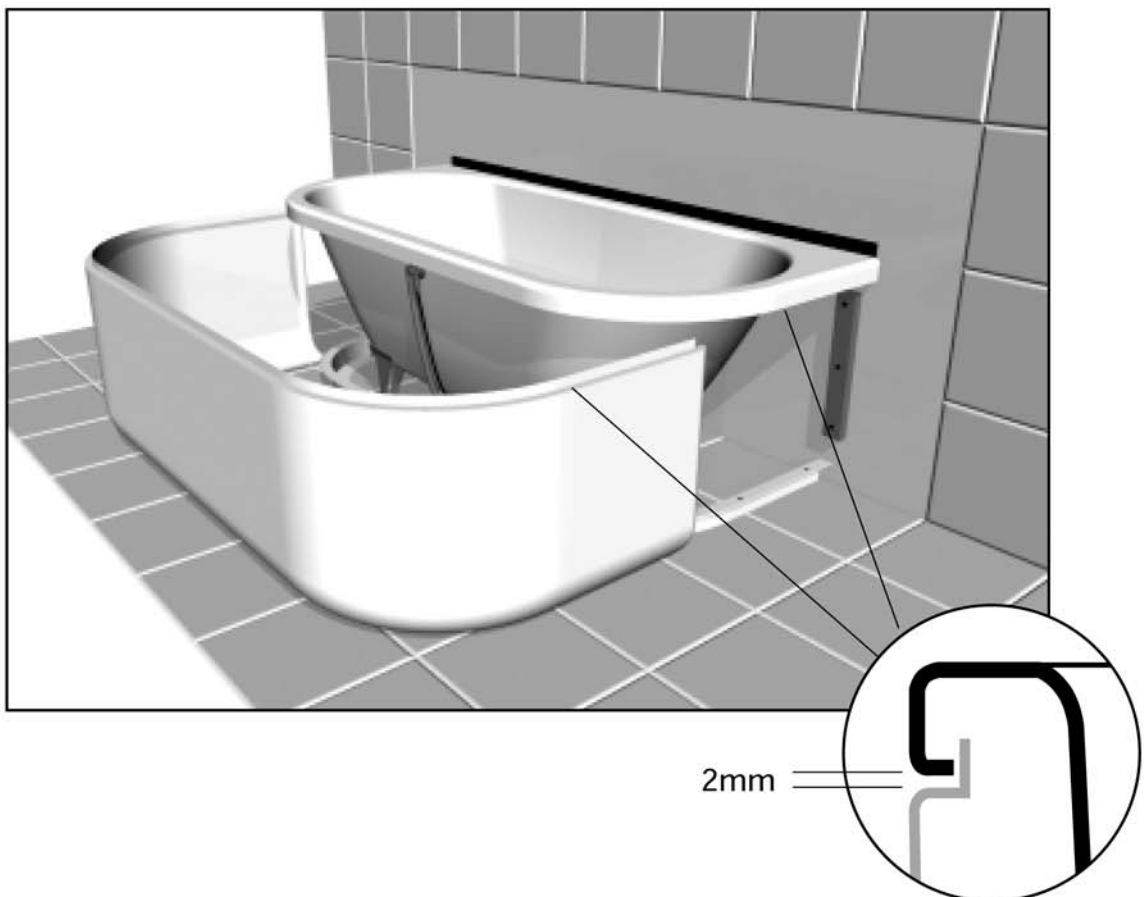

Installation Instructions

6.

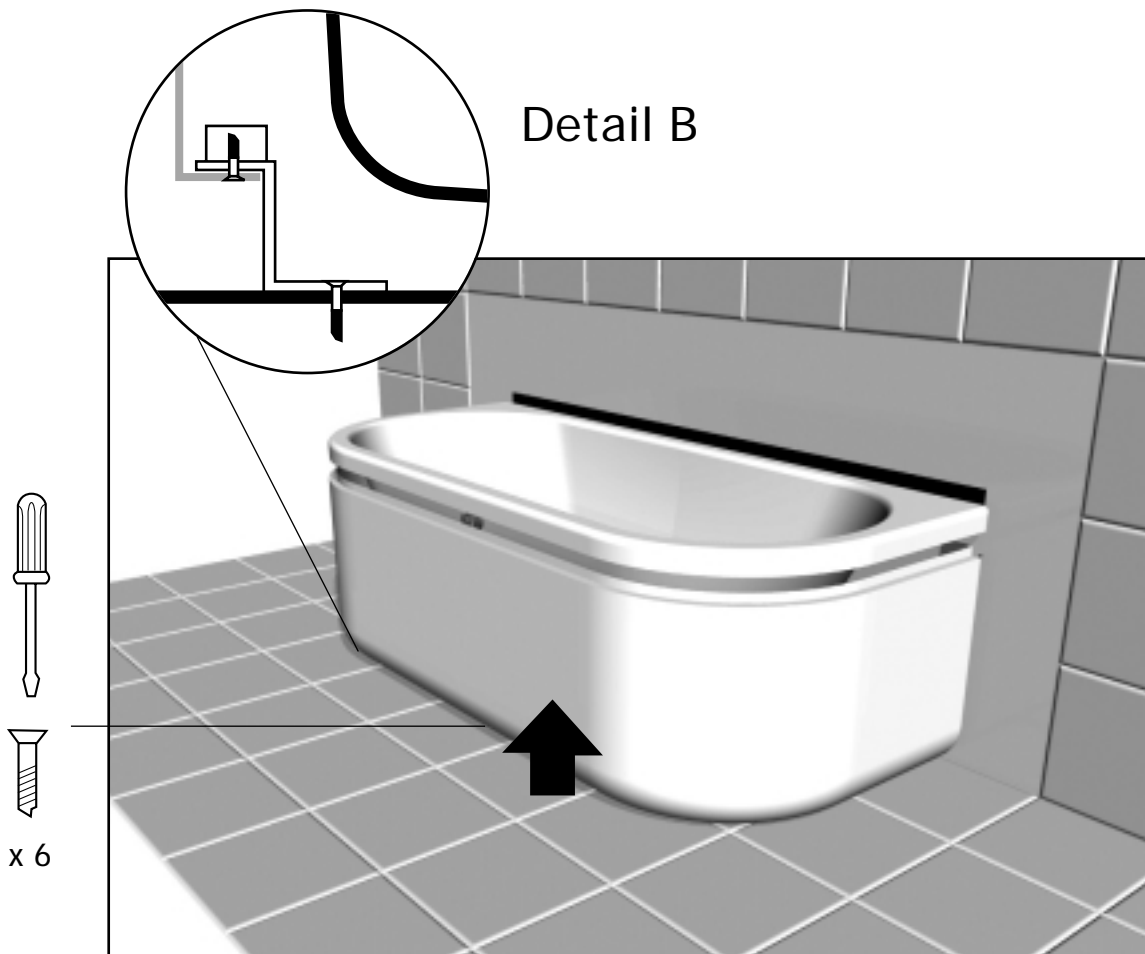
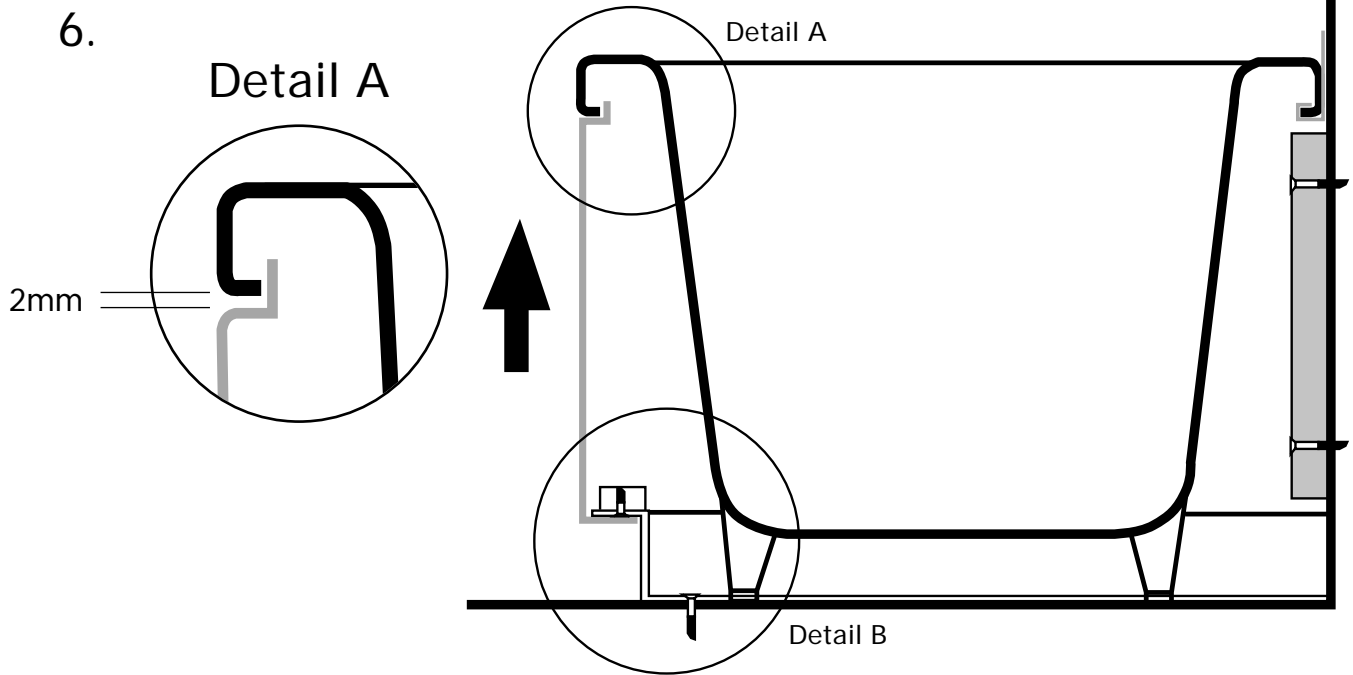

Installation Instructions

7.

